

PARTS LIST
**MUSTANG 1500
BURNISHER**

NON-VAC-TRAC

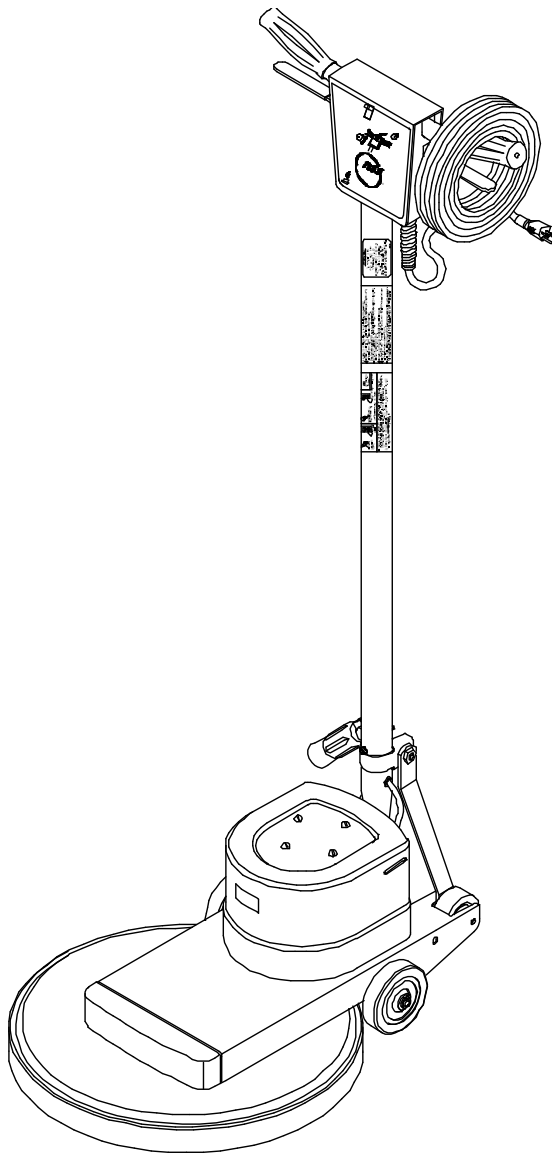

VAC-TRAC

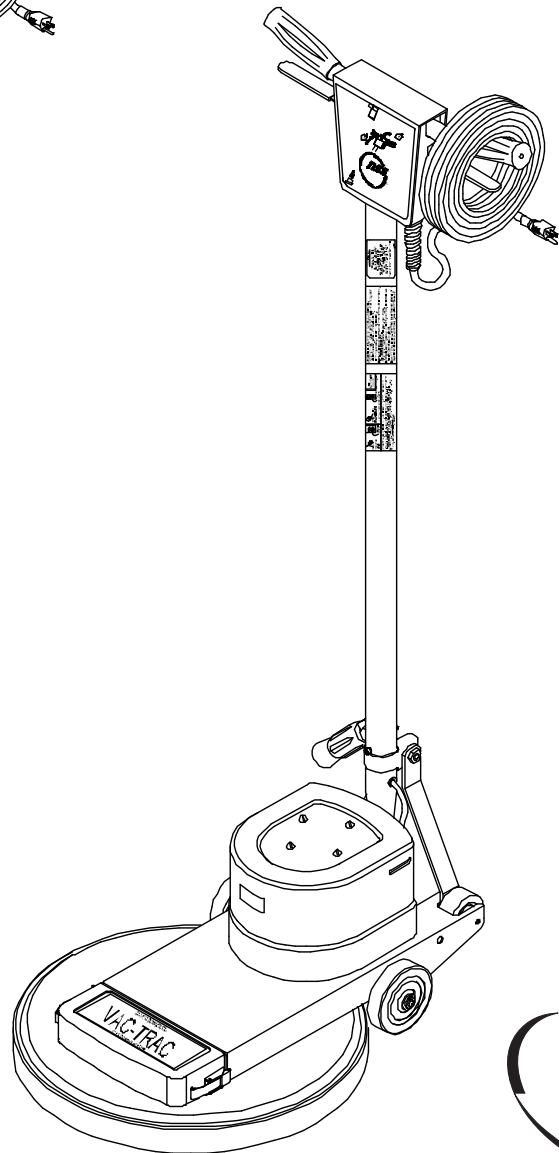

HANDLE ASSEMBLY

<u>ITEM</u>	<u>PART NO.</u>	<u>PART DESCRIPTION</u>	<u>QTY.</u>
	5990189	COMPLETE HANDLE ASSEMBLY - 120 VOLT	1
	5990199	COMPLETE HANDLE ASSEMBLY - 240 VOLT	1
101	5392421	DECAL - "SWITCH BOX WITH CIRCUIT BREAKER ICON"	1
102	0393511	LOCKOUT BRACKET	1
103	0393521	LOCK OUT	1
104	9120828	1/8 X 1 3/4 ROLL PIN	2
105	5390171	SWITCH LEVER SPRING	2
106	0393411	GRIP - SWITCH LEVER	2
107	0393401	SWITCH LEVER	1
108	5391321	WIRE NUT - ORANGE - 120 VOLT ONLY	1
109	0294031	# 8 RING TERMINAL	1
110	9120100	6-32 X 1 ROUND HEAD PHILLIPS MACHINE SCREW	2
111	9120130	6 EXTERNAL STAR LOCK WASHER	2
112	5390211	SWITCH	1
113	5390361	SWITCH INSULATOR	1
114	9120380	10-24 X 3/8 ROUND HEAD PHILLIPS MACHINE SCREW	1
115	9120320	10 SPLIT LOCK WASHER	1
116	0298981	# 10 RING TERMINAL 14-16 GAGE	1
117	5392401	DECAL - "WARNING - FIRE"	1
118	0190901	DECAL - "WARNING" - 120 VOLT ONLY	1
	0190921	DECAL - "ICON ADAPTOR" - 240 VOLT ONLY	1
119	0190911	DECAL - "GROUNDING" - 120 VOLT ONLY	1
120	5490441	INSULATION - BREAKER LEAD	1
121	9120430	10-24 X 3/4 ROUND HEAD PHILLIPS MACHINE SCREW	2
122	5294381	17 1/2 AMP CIRCUIT BREAKER - 120 VOLT ONLY	1
	5294581	8 AMP CIRCUIT BREAKER - 240 VOLT ONLY	1
123	9120320	10 SPLIT LOCK WASHER	2
124	9120360	10-24 HEX NUT WITH STAR LOCK WASHER	2
125	5490451	CIRCUIT BREAKER LEAD - 4"	1
126	9120200	8 SPLIT LOCK WASHER	1
127	9120223	8-32 X 1/4 PAN HEAD PHILLIPS MACHINE SCREW	1
128	5990651	HANDLE	1
129	5390511	FOAM PAD	1
130	9120320	10 SPLIT LOCK WASHER	1
131	9120615	10-24 X 3/8 SOCKET HEAD CAP SCREW	1
132	5090441	NYLON BUSHING	2
133	5490861	HANDLE CORD	1
134	5293131	GROMMET	1
135	5091561	CORD 50 FEET 14-3 - 120 VOLT ONLY	1
	5293791	CORD 75 FEET 14-3 - 120 VOLT ONLY - OPTIONAL	1
	0299671	SHUKO CORD - 75 FEET - 16-3 - 240 VOLT ONLY	1
136	9120080	6-32 X 3/4 ROUND HEAD PHILLIPS MACHINE SCREW - 240 VOLT ONLY	1
137	5391931	TERMINAL BLOCK - 240 VOLT ONLY	1
138	5391921	WIRE - GROUND - 240 VOLT ONLY	1
139	5391911	WIRE - DEAD MAN - 240 VOLT ONLY	1
140	5091671	STRAIN RELIEF - 120 VOLT ONLY	1
	0299531	STRAIN RELIEF - 240 VOLT ONLY	1
141	5390261	STRAIN RELIEF NUT - 120 VOLT ONLY	2
	0891131	STRAIN RELIEF NUT - 240 VOLT ONLY	1
142	5092371	STRAIN RELIEF CORD CLAMP - 120 VOLT ONLY	1
	0299661	STRAIN RELIEF CORD CLAMP - 240 VOLT ONLY	1
143	5091656	7/8 I.D. X 1 3/8 O.D. X .112 THICK FLAT WASHER	1
144	5095501	CORD CLAMP	1
145	8791070	VINYL HOSE	1
146	9120025	6-32 DOUBLE HOLE SWITCH SPEED NUT	1
147	0393441	HANDLE GRIP	2
148	9120320	10 SPLIT LOCK WASHER	1
149	9120380	10-24 X 3/8 ROUND HEAD PHILLIPS MACHINE SCREW	1
150	0393381	SPRING	1
151	0393881	M3 X .05 X 8mm PAN HEAD PHILLIPS THREAD CUTTING SCREW	2
152	0393841	M3 EXTERNAL STAR LOCK WASHER	2
153	9120320	10 SPLIT LOCK WASHER	1

HANDLE ASSEMBLY

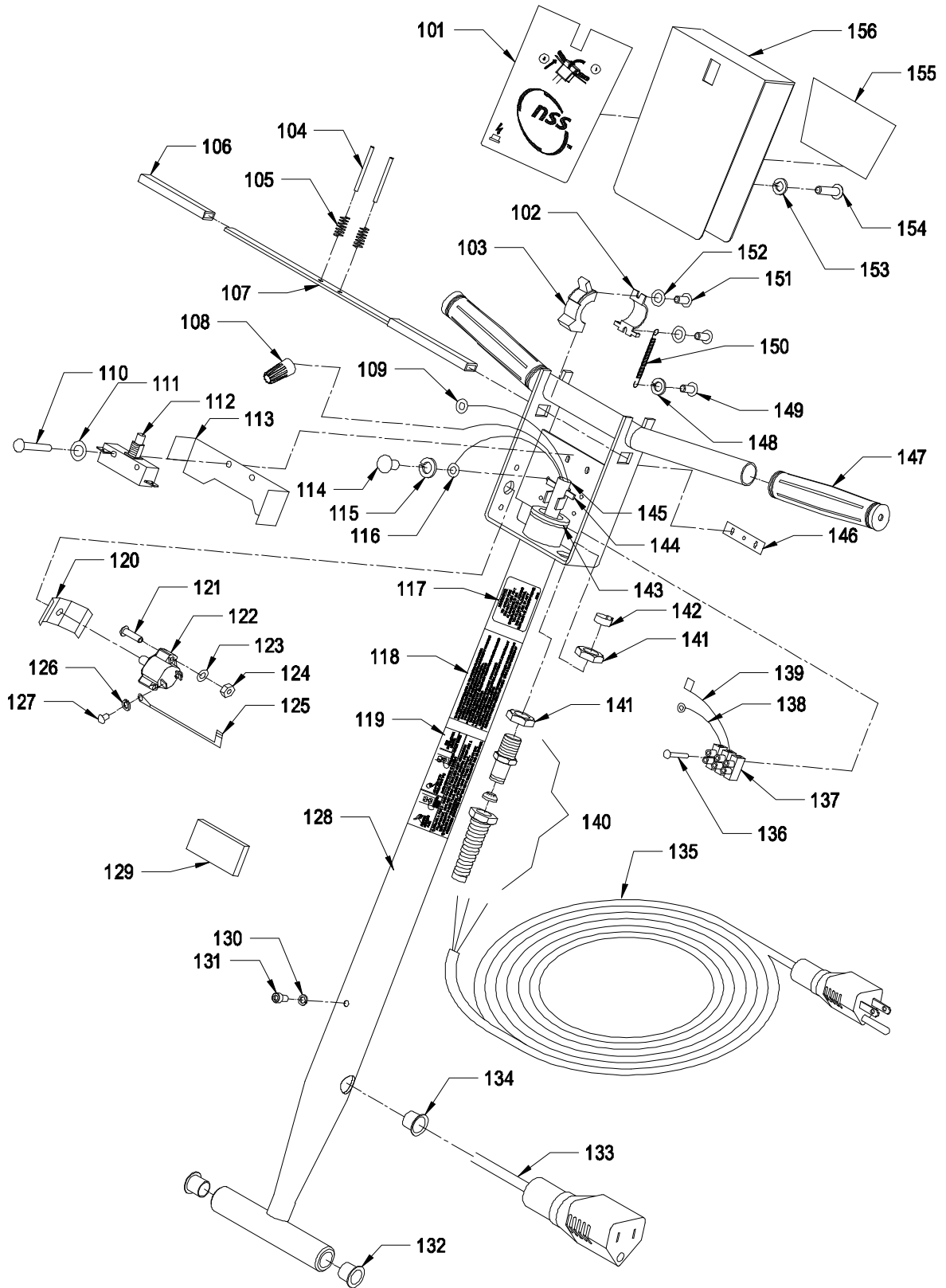

154	9120430	10-24 X 3/4 ROUND HEAD PHILLIPS MACHINE SCREW	1
155	5392451	DECAL - "INSTRUCTION"	1
156	5391873	SWITCH BOX COVER	1

UPPER BASE ASSEMBLY

<u>ITEM</u>	<u>PART NO.</u>	<u>PART DESCRIPTION</u>	<u>QTY.</u>
201	9120740	10-32 X 3/8 TRUSS HEAD PHILLIPS MACHINE SCREW	4
202	5294291	MOTOR COVER	1
203	0393531	NSS LOGO DECAL	1
204	9120210	8-32 X 1/4 TRUSS HEAD PHILLIPS MACHINE SCREW	3
205	5294706	COVER STAND OFF	1
206	5991511	MOTOR 120 VOLT	1
	5298361	MOTOR 240 VOLT	1
207	9120827	3/16 SQUARE X 1 LONG KEY	1
208	5990063	FRAME	1
209	9122050	3/8-16 X 1 1/2 SET SCREW - CUP POINT	1
210	9121990	3/8-16 HEX JAM NUT	1
211	9122496	RETAINING RING	2
212	9122465	.516 I.D. X .813 O.D. X .027/.030 THICK FLAT WASHER	2
213	5092591	WHEEL - 5" - WITH PLASTIC BEARING	2
214	9122465	.516 I.D. X .813 O.D. X .027/.030 THICK FLAT WASHER	2
215	5091711	WHEEL SPRING	2
216	9122450	17/32 I.D. X 1 1/16 O.D. X .074/.121 THICK SAE FLAT WASHER (1/2)	2
217	5990121	WHEEL AXLE	1
218	9122496	RETAINING RING	2
219	5990101	HANDLE PIVOT	1
220	9122370	3/8-16 X 3 3/4 HEX BOLT	2
221	9122140	3/8-16 HEX NUT WITH NY-LOK INSERT	2
222	9122050	3/8-16 X 1 1/2 SET SCREW - CUP POINT	1
223	9121990	3/8-16 HEX JAM NUT	1
224	9122496	RETAINING RING	2
225	5091711	WHEEL SPRING	2
226	9122450	17/32 I.D. X 1 1/16 O.D. X .074/.121 THICK SAE FLAT WASHER (1/2)	2
227	5990111	WHEEL SPACER	2
228	2790281	3" BUMPER WHEEL	2
229	9122450	17/32 I.D. X 1 1/16 O.D. X .074/.121 THICK SAE FLAT WASHER (1/2)	2
230	9122496	RETAINING RING	2
231	5390026	HANDLE BRACE	2
232	9122140	3/8-16 HEX NUT WITH NY-LOK INSERT	1
233	5390826	TUBE CLAMP SHOE	1
234	5990651	HANDLE	1
235	5390043	TUBE CLAMP	1
236	5390201	RUBBER TUBING	1
237	0393141	FLATTENED CLAMP BOLT	1
238	0393131	SLOTTED WASHER	1
239	9121420	5/16-18 HEX NUT	1
240	0393121	CLAMP LEVER	1
241	0393321	HANDLE GRIP	1
242	9121680	5/16-18 X 1 HEX BOLT	1

UPPER BASE ASSEMBLY

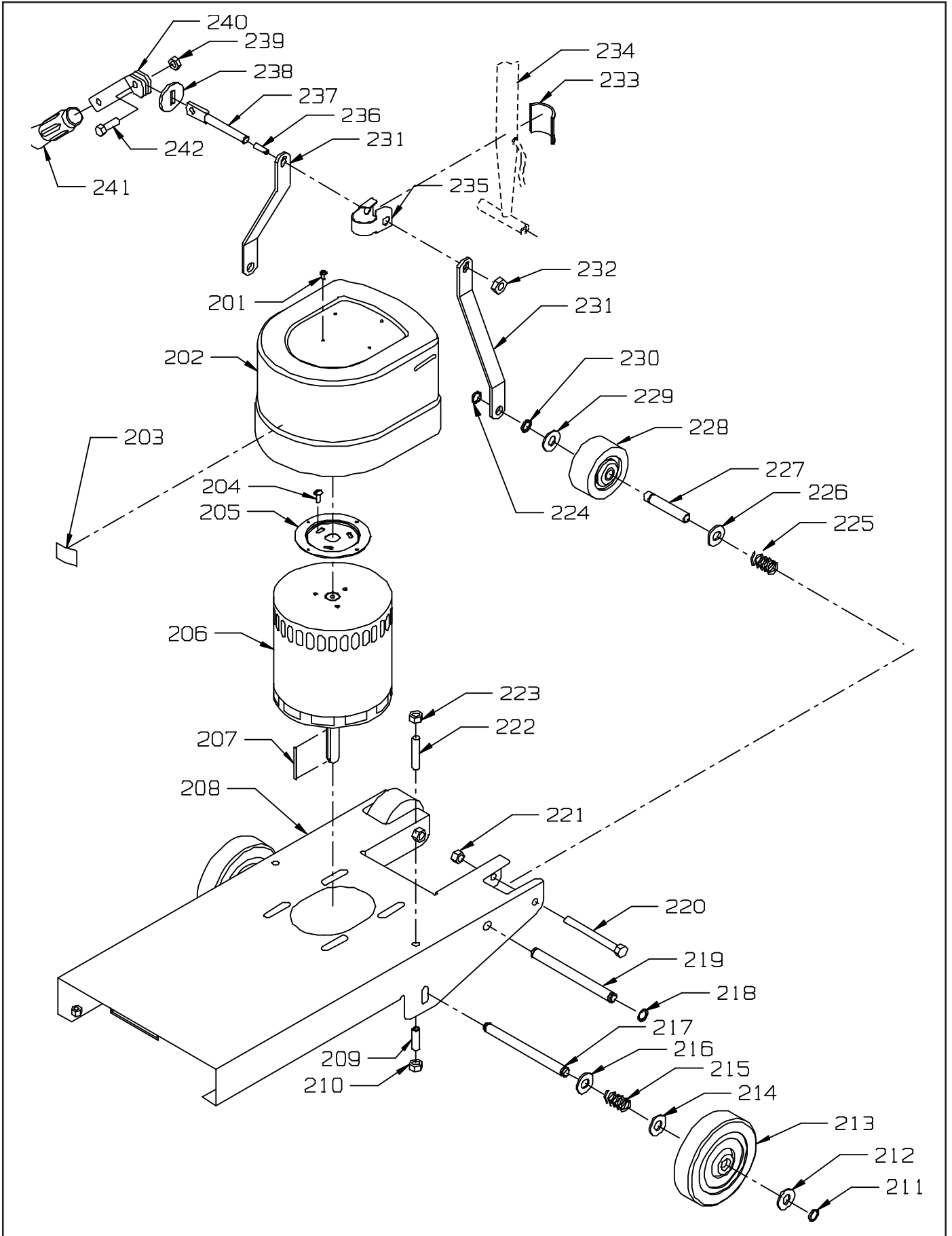

LOWER BASE ASSEMBLY

<u>ITEM</u>	<u>PART NO.</u>	<u>PART DESCRIPTION</u>	<u>QTY.</u>
301	5990063	FRAME	1
302	5990011	BEARING BLOCK AND SHAFT - INCLUDES:	1
303	9120303	1/8 SQUARE X 1/2 LONG KEY	1
304	9121520	5/16 SPLIT LOCK WASHER	2
305	9121680	5/16-18 X 1 HEX BOLT	2
306	5293059	PULLEY - INCLUDES:	1
307	9121043	1/4 X 1 1/8 ROLL PIN	4
308	9121045	1/4-20 X 1/2 ROUND HEAD PHILLIPS MACHINE SCREW	2
309	9120970	1/4 EXTERNAL STAR LOCK WASHER	2
310	5990091	PULLEY COVER - NON VAC TRAC ONLY	1
311	5990261	DUST COLLECTION BOX - VAC TRAC ONLY	1
312	9120319	5/32 X 3/8 DOME HEAD POP RIVET - VAC TRAC ONLY	4
313	6793181	CLAMP - VAC TRAC ONLY	2
314	5990291	DUST COLLECTION FILTER - VAC TRAC ONLY	1
315	5991481	DUST COLLECTOR LABEL - VAC TRAC ONLY	1
316	9120185	5/32 I.D. X 1/2 O.D. WASHER - VAC TRAC ONLY	2
317	9120317	5/32 X 5/8 DOME HEAD POP RIVET - VAC TRAC ONLY	2
318	6793171	BUTTON - VAC TRAC ONLY	2
319	5990281	DUST COLLECTION SCOOP - VAC TRAC ONLY	1
320	9120970	1/4 EXTERNAL STAR LOCK WASHER - VAC TRAC ONLY	2
321	9120810	10 X 1/2 PAN HEAD SHEET METAL SCREW	2
	9121045	1/4-20 X 1/2 ROUND HEAD PHILLIPS MACHINE SCREW - VAC TRAC ONLY	2
322	5990021	BUMPER - NON VAC TRAC ONLY	1
	5990221	BUMPER - DUST COLLECTION - VAC TRAC ONLY	1
323	5990759	FLEXIBLE PAD DRIVER ASSEMBLY - INCLUDES:	1
	5990741	PAD DRIVER	
324	5990759	PAD DRIVER PLATE	1
325	5990731	SPRING CLIP PAD HOLDER SET INCLUDES:	1
326	9120140	#6 X 5/8 PAN HEAD PHILLIPS SHEET METAL SCREW	3
327	—	PAD - SEE ACCESSORIES PAGE FOR OPTIONS	1
328	9122507	1/2-13 HEX NUT WITH NY-LOK INSERT	1
329	9122450	17/32 I.D. X 1 1/16 O.D. X .074/.121 THICK FLAT WASHER (1/2)	1
330	9121640	5/16-18 X 3/4 HEX BOLT	4
331	9121520	5/16 SPLIT LOCK WASHER	4
332	5990053	SKIRT - NON VAC TRAC ONLY	1
	5990253	SKIRT - DUST COLLECTION - VAC TRAC ONLY	1
333	5294501	BELT	1
334	4991081	3/4 I.D. X 1 1/4 O.D. X .031 THICK FLAT WASHER	1
335	5294491	MOTOR PULLEY INCLUDES:	1
336	9121380	5/16-18 X 3/8 SET SCREW - KNURL POINT	1
337	9122030	3/8-16 X 3/4 BUTTON HEAD SOCKET SCREW	4
338	9122100	3/8-16 SPLIT LOCK WASHER	4
339	9121980	7/16 I.D. X 1 O.D. X .075/.080 THICK FLAT WASHER (3/8)	4

LOWER BASE ASSEMBLY

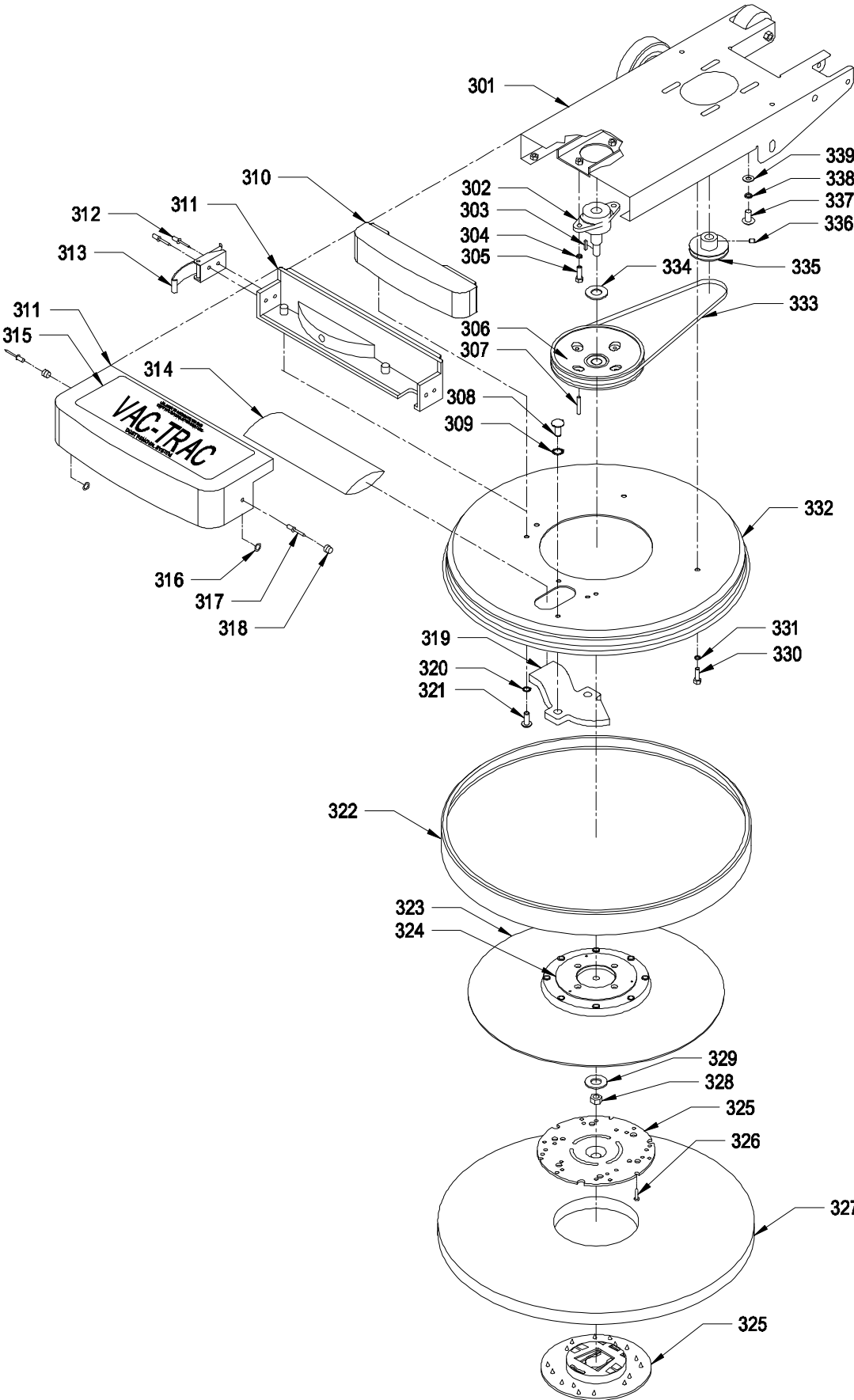

MOTOR ASSEMBLY

<u>ITEM</u>	<u>PART NO.</u>	<u>PART DESCRIPTION</u>	<u>QTY.</u>
	<u>5991511</u>	<u>COMPLETE MOTOR - 115 VOLT - 1.5 H.P.</u>	
401	-----	COMMUTATOR BRACKET ASSEMBLY WITH BRUSH, BOARD, LEADS	1
	5991571	COMMUTATOR BRACKET	1
	5991731	COMMUTATOR BRACKET COVER	1
402	5991701	THRU BOLT	2
403	5991611	BRUSH BOARD ASSEMBLY WITH BRUSHES, SPRINGS, DETECTORS, LEADS	1
	5991641	VARISTOR ASSEMBLY WITH SLEEVING AND TERMINALS	1
404	5991621	RED LEAD ASSEMBLY	1
405	5991631	YELLOW LEAD ASSEMBLY	1
406	5293651	CARBON BRUSH	1
407	2797571	BRUSH SPRING	1
408	5991601	10-24 X 1/2 SELF TAPPING SCREW	4
409	5991721	BRACKET - BOTTOM END	1
410	-----	SHAFT KEY	1
411	5991531	ARMATURE ASSEMBLY INCLUDES:	1
412	5991541	BEARING - BOTTOM END	1
413	5991551	BEARING - TOP END	1
414	5991741	HELICAL WASHER	1
415	5991521	STATOR FRAME ASSEMBLY - WITH CLIPS AND MAGNETS	1
416	5991661	8-32 X 1.125 MOUNTING SCREW	1
417	5991671	M8 FLAT WASHER - BRASS	1
418	5492741	RECTIFIER	1
419	5991681	HEX NUT WITH STAR LOCK WASHER	1
420	5991581	HOLE PLUG	1
421	5991691	MOTOR CORD	1
422	5991591	STRAIN RELIEF	1
	<u>5298361</u>	<u>COMPLETE MOTOR 240 VOLT - 1.5 H.P.</u>	
401	5991821	COMMUTATOR BRACKET ASSEMBLY WITH BRUSH, BOARD, LEADS	1
	5991571	COMMUTATOR BRACKET	1
	5991731	COMMUTATOR BRACKET COVER	1
402	5991701	THRU BOLT	2
403	5991831	BRUSH BOARD ASSEMBLY WITH BRUSHES, SPRINGS, DETECTORS, LEADS	1
	5991841	VARISTOR ASSEMBLY WITH SLEEVING AND TERMINALS	1
404	5991621	RED LEAD ASSEMBLY	1
405	5991631	YELLOW LEAD ASSEMBLY	1
406	5991861	CARBON BRUSH	1
407	2797571	BRUSH SPRING	1
408	5991601	10-24 X 1/2 SELF TAPPING SCREW	4
409	5991721	BRACKET - BOTTOM END	1
410	-----	SHAFT KEY	1
411	5991811	ARMATURE ASSEMBLY INCLUDES:	1
412	5991541	BEARING - BOTTOM END	1
413	5991551	BEARING - TOP END	1
414	5991741	HELICAL WASHER	1
415	5991521	STATOR FRAME ASSEMBLY - WITH CLIPS AND MAGNETS	1
416	5991661	8-32 X 1.125 MOUNTING SCREW	1
417	5991671	M8 FLAT WASHER - BRASS	1
418	5991851	RECTIFIER	1
419	5991681	HEX NUT WITH STAR LOCK WASHER	1
420	5991581	HOLE PLUG	1
421	5991691	MOTOR CORD	1
422	5991591	STRAIN RELIEF	1

MOTOR ASSEMBLY

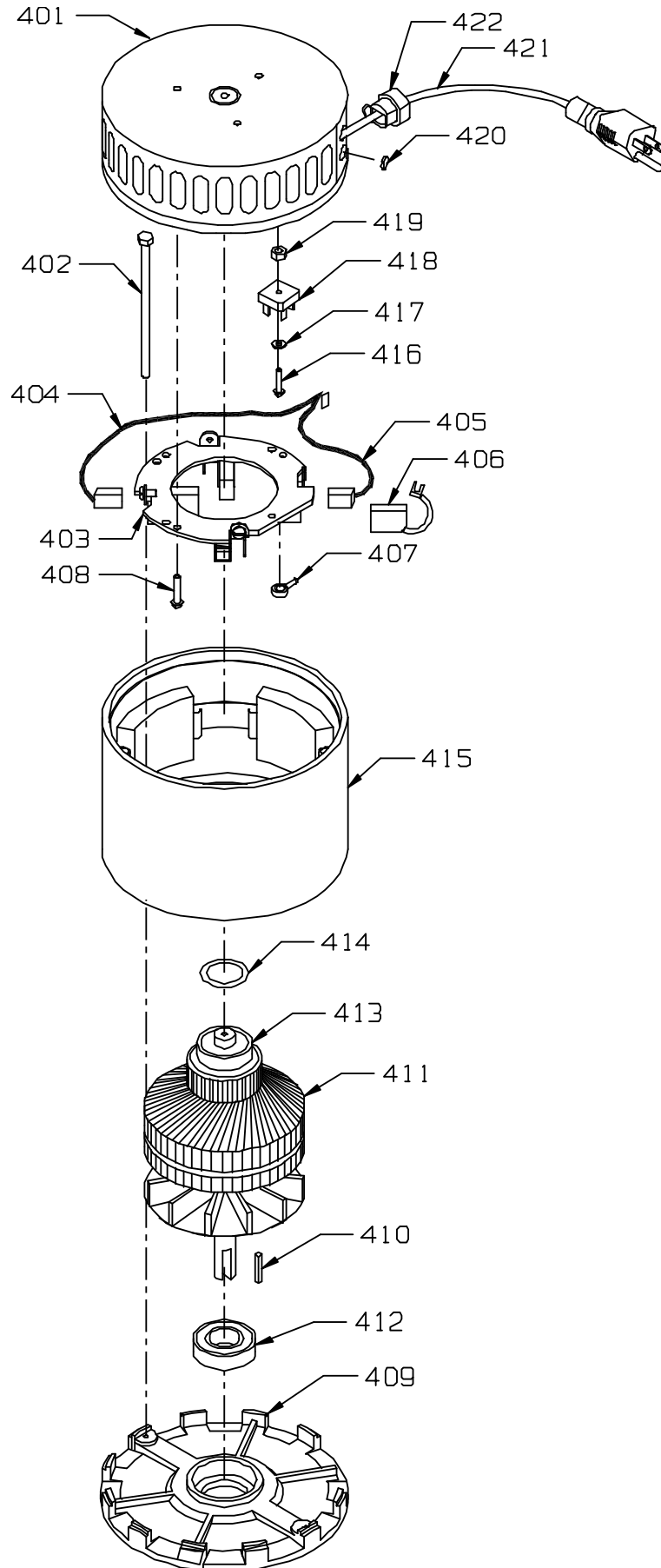

WIRE DIAGRAM

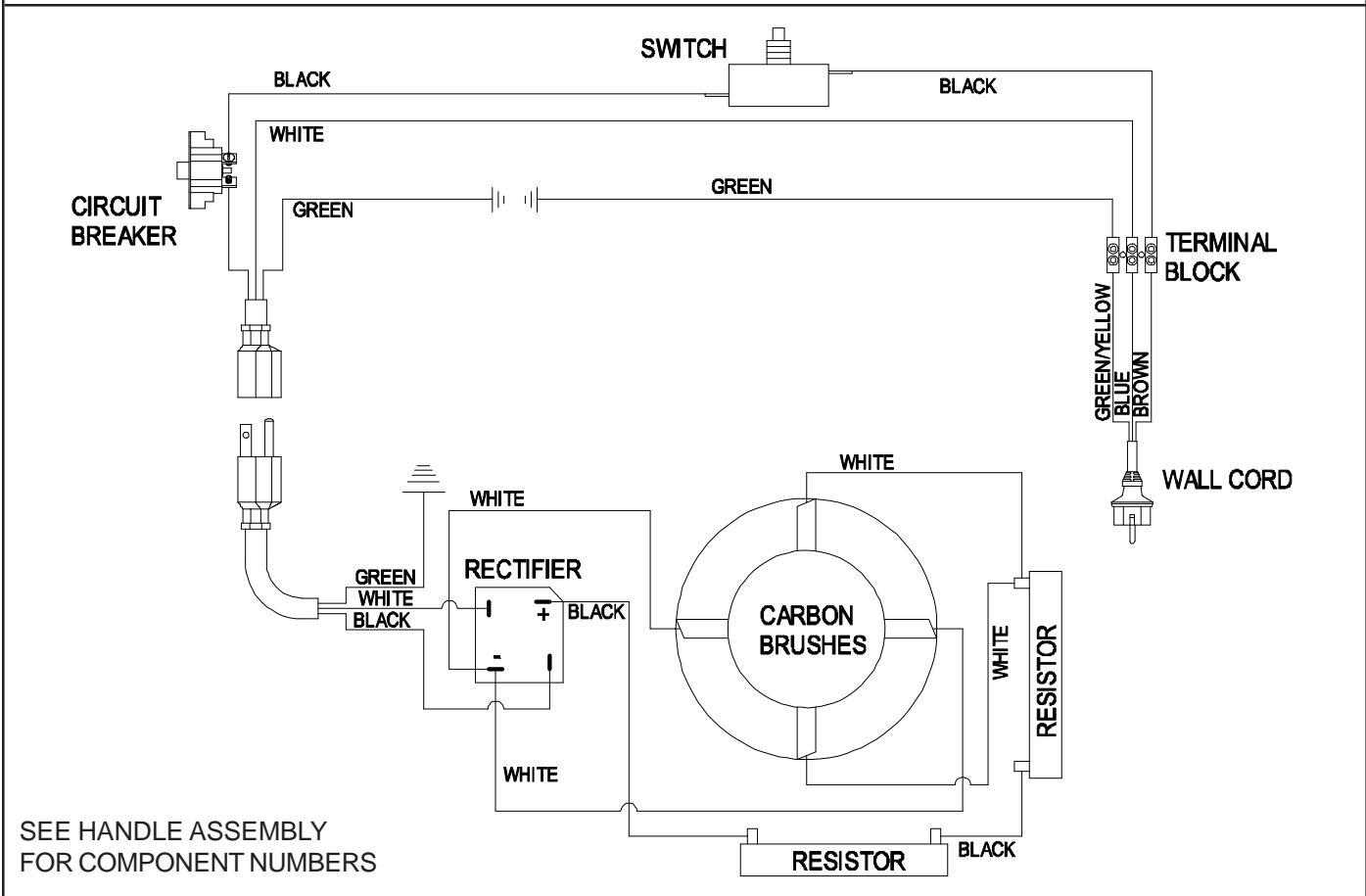
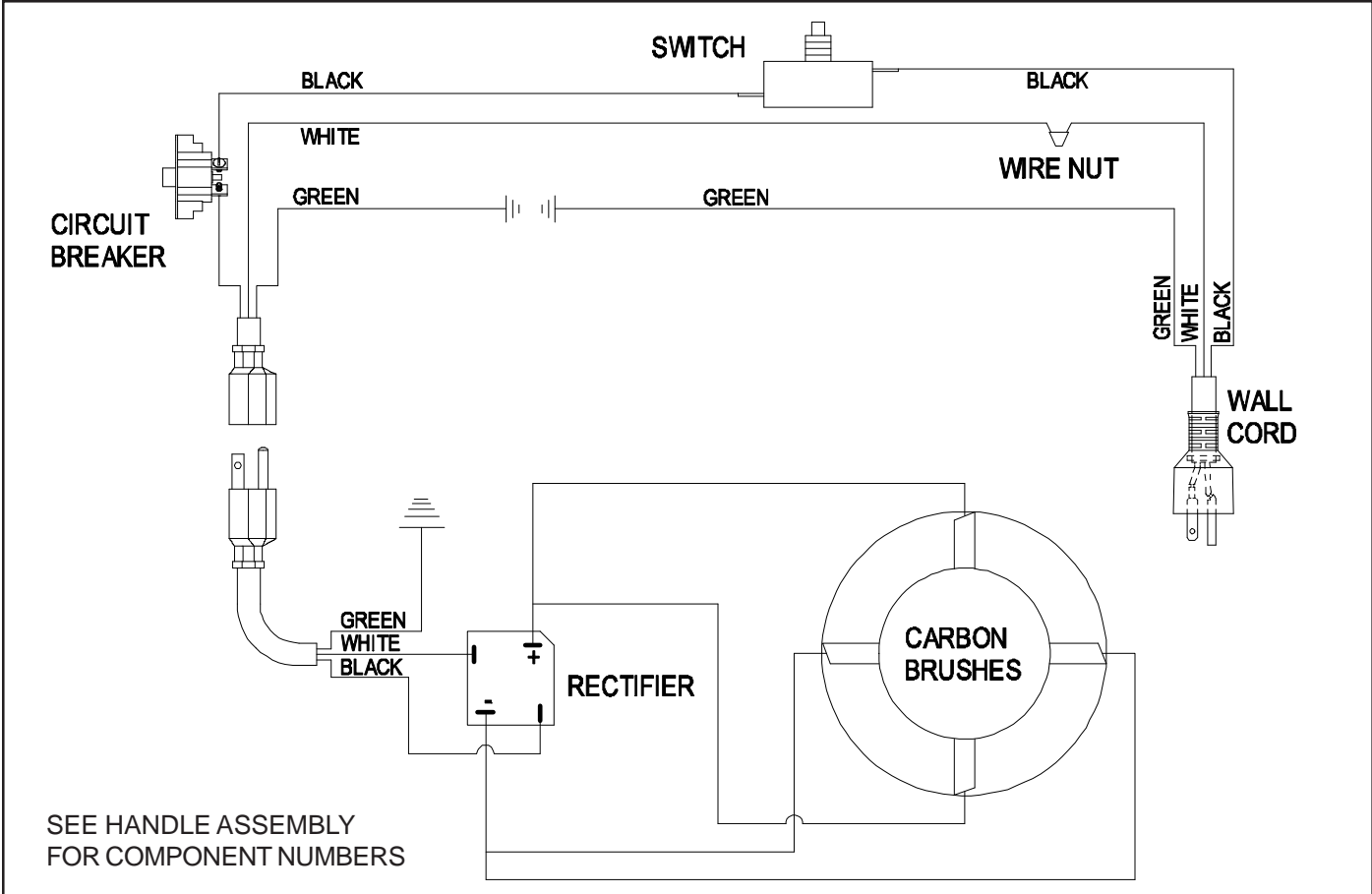

ACCESSORIES



PART NO.

NOTE:

7992051

7992061

7992081

7992091

7992021

7992001

7992011

PART DESCRIPTION

ALL PADS COME 5 PADS PER CASE

20" LITE BLUE POLISH / BURNISH PAD - FOR SOFT FINISH

20" LITE HAIR BURNISH PAD - FOR ALL FINISHES

20" ULTRA HAIR HARD FINISH PAD - FOR HARD FINISH

20" ULTIMATE HAIR PAD - HARD FINISH AGGRESSIVE BURNISHING

20" GREEN SCRUB PAD - HEAVY FINISH REMOVAL

20" BLACK STRIP PAD - REMOVES FINISH COMPLETELY

20" BROWN STRIP PAD - REMOVES FINISH COMPLETELY



NSS ® Enterprises, Inc.

3115 Frenchmens Road, Toledo, Ohio 43607
PHONE (419) 531-2121 FAX (419) 531-3761

NSS ® Enterprises, Inc. European Distribution Centre
Unit II, Pinfold Trading Estate * 55 Nottingham Road
STAPLEFORD, NOTTINGHAM NG9 8AD ENGLAND U.K.
PHONE: (44) 0115 939 1568 * FAX: (44) 0115 949 0615