

PREDATOR CX300HP

IMPORTANT SAFETY INSTRUCTIONS

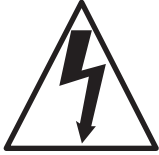

READ AND UNDERSTAND ALL INSTRUCTIONS
BEFORE OPERATING OR SERVICING MACHINE

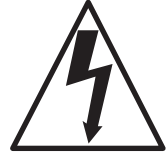

DANGER!

Failure to Observe These Instructions Can Cause Personal Injury
to Machine Operator, By-standers or Possible Machine Damage.

- **NEVER** attempt to service or perform maintenance functions while machine is plugged into an electrical outlet.
- **ALWAYS** unplug machine before attempting to service the motorized brush attachment.
- **NEVER** operate in standing water. **NEVER** expose to rain. **ALWAYS** store indoors.
- **NEVER** overfill recovery tank or allow water to enter vacuum standpipe. This will cause damage to the vacuum motor and possible electrocution.
- **NEVER** operate machine with a cut, abraded or taped cord.
- **NEVER** operate machine with a broken grounding blade on the plug.
- **ALWAYS** replace the entire cord when the cord or plug is damaged in any manner.
- **NEVER** handle the machine, cord or plug with wet hands.
- **NEVER** drop or insert any object into any machine opening.
- **ALWAYS** keep face, fingers, hair or any other body part, or loose clothing away from any machine opening or any moving part, particularly the revolving brush.
- **NEVER** leave the machine unattended when plugged in. Unplug the machine from the electrical outlet when not in use.
- **ALWAYS** turn the machine off before unplugging it from the electrical outlet.
- **NEVER** operate this machine in the presence of flammable or combustible liquids or fumes.
- When any electrical motor, switch, cord or plug service is required, maintenance should only be done by an authorized service station, an electrician or other qualified persons.
- **NEVER** operate this machine if it is not working properly, if it has been dropped, damaged, exposed to weather, or dropped into water. Return the machine to a service center for examination and repair.
- **NEVER** operate this machine with any air opening blocked. Keep all air openings free of dust, lint, hair, ect.
- **NEVER** operate this machine without solution tank filter screens or vacuum standpipe filter screen in place or if they are clogged. Clean all filter screens after every use.
- **ALWAYS** store this machine indoors. Protect it from rain or snow.
- **NEVER** spray the top of the machine with liquids.
- **DO NOT** pull or carry this machine by the electrical supply cord, use the cord as a handle, close a door on the cord, pull the cord around sharp edges or corners, or expose to heated surfaces.
- **NEVER** disconnect the plug by pulling on the cord. To disconnect the cord from the outlet grasp the plug, not the cord.
- **ALWAYS** unplug this machine before attempting to service.
- **ALWAYS** use a defoamer which will prevent a buildup of foam in the recovery tank. If a defoamer is not used, the motor can be damaged from shampoo being pulled into the vacuum motor.

SAVE THESE INSTRUCTIONS



INFORMATION & OPERATING INSTRUCTIONS

**DO NOT OPERATE MACHINE UNTIL YOU HAVE READ THIS SECTION
IMPROPER USE OF THE PREDATOR CX300HP WILL VOID THE WARRANTY**

1. Always use a rag to prevent burns when handling quick-disconnects.
2. Always use a defoamer when foaming occurs to prevent vacuum motor damage.
3. To keep fitting and lines from damage during freezing conditions, use an anti-freeze in the pump and heater or keep equipment inside heated areas.
4. Do not let pump run dry.
5. Use neutral pH, water-based products only - NO SOLVENTS!

INSPECTION:

Carefully unpack and inspect the PREDATOR CX300HP for shipping damage. Each unit is tested and inspected before shipment. Any damage incurred is the responsibility of the carrier, who should be notified immediately.

CLEANING SOLUTIONS:

We recommend liquid cleaning chemicals. Powders may be used, but unless mixed very thoroughly, they could cause build-up in the lines, pump, quick-disconnects, etc. A pH of 7-9 is strongly recommended to avoid premature pump wear, which would void the warranty.

MAINTENANCE:

For optimum performance, flush the machine with clear water at the end of each working day. Once a month, minimum, run a flushing compound through the machine to cut any alkaline build-up that may have formed.

Lubricate wheels, casters and hinges as needed. The pump and vacuum motor do not require any maintenance.

The body can be cleaned with a general all-purpose detergent and protected with a silicone type product like Armor All®. The quick-disconnects should be lubricated with silicone, also.

Prior to each job, inspect the holding tank filter and the recovery tank float filter for hair and dirt. The drain valve should also be inspected regularly and kept free of any debris or build-up.

SET-UP:

Fill the holding tank with clear water and the detergent of your choice. Mix well. Although this machine is designed to supply instant hot water, the addition of warm or hot water to the holding tank would be a plus factor.

1. Plug in cord #1 (vac and pump), identified by the 4" long red band on the end of the cord. Attach the priming hose to the machine. Turn the pump on and set the switch to the upholstery setting. Run until the pump is fully primed, then turn off the pump. Remove the priming hose and attach the cleaning hoses and tool.
2. Turn on the pump and spray through the cleaning tool for a few seconds to fill the lines with solution.
3. Plug in cord #2. IF THE GREEN LIGHT ILLUMINATES, THE HEAT EXCHANGER WILL TURN ON AUTOMATICALLY (SEE NOTE BELOW). Wait 2 minutes for the heat exchanger to reach operating temperature. You may now begin cleaning. It will take about 10 seconds for the initial heat to reach the wand.

NOTE: 240 Volt machines do not have a green light.

NOTE: If the green circuit indicator light does not illuminate when cord #2 is plugged in, then both cords are on the same line. Try other outlets until the light comes on. See the bypass switch section (below) if you are unable to get a green light.

BYPASS SWITCH:

NOTE: 240 Volt machines do not have a Bypass Switch.

The bypass switch completely bypasses the circuit locator. Use this feature when you cannot get the green light to come on and you believe that the two cords are on separate circuits.

CAUTION: If the bypass switch is on and the two cords are plugged into the same circuit, the breaker will blow.

ELECTRIC CIRCUIT LOCATOR:

NOTE: 240 Volt machines do not have an Electronic Circuit locator.

This unique, patented "smart system", operated by a solid state circuit, will inform the operator when the two cords are plugged into separate lines by illuminating the green indicator light. This helps prevent tripping circuit breakers.

BALL FLOAT VAC SHUTOFF:

When the recovery tank is full, the float system will shut off the incoming air flow and prevent water from entering the vacuum motor. The float may not work properly if the float filter is clogged or if there is heavy foam in the tank.

CAUTION: To avoid vac motor damage, always make sure the float filter is clean and the ball travels freely before turning on the machine. Use a defoamer whenever foam is present.

SAFETY PRECAUTIONS:

All extension cords must have a rating of at least 12/3 (#12 cord). Extension cords should be no longer than 50 feet. Replace the plug immediately if the ground prong becomes damaged or is broken off. Not only is the ground necessary for safety, but the circuit locator system will not operate correctly without it.

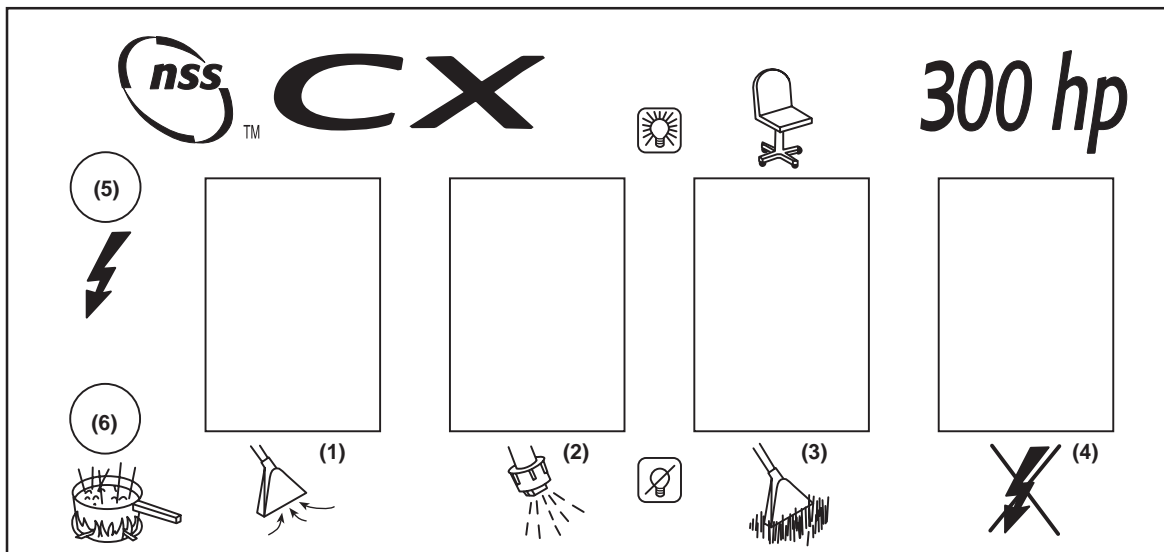

VAC (1) & PUMP (2) SWITCHES: These switches are powered by cord #1 (4" red band). Switches are on when illuminated.

CARPET/UPHOLSTERY SWITCH (3): This switch is also powered by cord #1 (4" red band). The carpet setting (down position) is high pressure (approximately 300PSI). The upholstery setting (up position) is low pressure (approximately 50PSI with a K1 or V2 spray tip). NOTE: Switch does not illuminate.

BYPASS SWITCH (4): Turning on this switch (switch illuminates when on) bypasses the circuit locator. See previous page for explanation of the bypass system.
(Not part of 240V machine)

GREEN CIRCUIT LOCATOR LIGHT (5): When this light is illuminated, it confirms that the machine is on two separate circuits. See previous page for additional information on the circuit locator.
(Not part of 240V machine)

HEAT MODE LIGHT (6): This light will only illuminate when the heater is heating and will turn off when it reaches operating temperature.

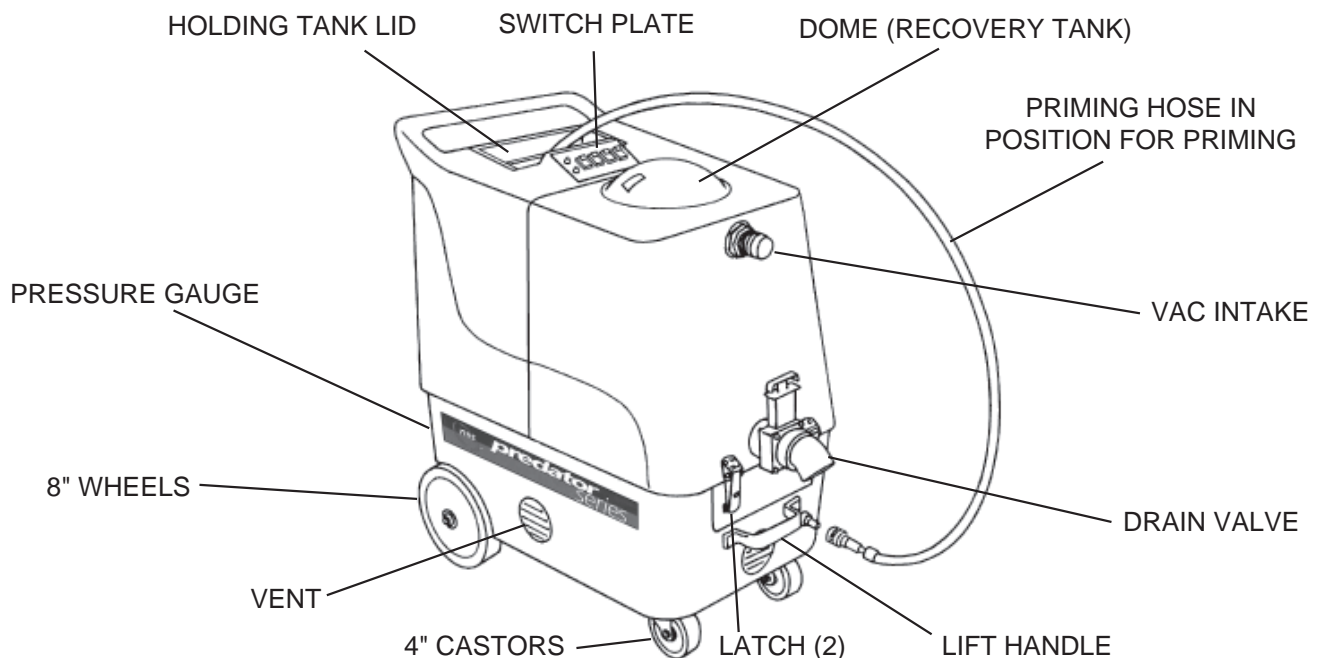

COMMON STAINS AND CLEANING TREATMENTS

TREATMENT METHODS

- First: Remove excess material by blotting to absorb liquids, or by scraping with a dull edge (butter knife) if a solid.
- Second: Clean the remaining stain as directed by the chart below. Always follow the direction on the container. Apply the cleaning material directly to the stain (avoid over wetting the carpet or upholstery), then remove the loosened stain material with a white absorbent cloth or tissue.
- Third: When the carpet is dry, gently brush the carpet pile to restore its appearance.
- Note: Treat unknown stains with a volatile solvent first and follow with other agents as required. If you are uncertain of the effect of the cleaning agent on the carpet fiber or dye, test on an inconspicuous area first.

STAIN TYPE

TREATMENT MATERIAL

Asphalt	Volatile solvent/detergent
Beer	Liquid detergent, White vinegar
Berry stain	Liquid detergent, Ammonia 3-6%, Water
Bleach	Liquid detergent, Water
Blood (dried)	Warm detergent, Ammonia 3-6%, Water
Blood (wet)	Liquid detergent, Water
Butter	Volatile solvent
Catsup or Mustard	Liquid detergent
Chewing gum	Volatile solvent
Chocolate	Liquid detergent, Ammonia water
Coffee	Detergent, White vinegar, Volatile solvent
Cola drink	Liquid detergent
Creme de Menthe (green)	Liquid detergent
Egg (raw)	Liquid detergent
Food dye	Liquid detergent, Water
Furniture dye or polish	Paint/Oil/Grease remover, Detergent
Gravy	Liquid detergent
Lipstick	Paint/Oil/Grease remover
Mascara	Paint remover, Volatile solvent, Detergent, Water
Milk	Liquid detergent
Orange drink	Liquid detergent, Water
Shoe polish	Heated iron into clean towel, Volatile solvent
Tea	Liquid detergent
Tomato Juice	Liquid detergent
Urine	Liquid detergent, Water
Vomit	Warm detergent, Water, White vinegar
Wine	Liquid detergent, Ammonia 3-6%, Water, Vinegar

PREDATOR CX300HP PARTS LIST

ITEM #	PART #	DESCRIPTION	ITEM #	PART #	DESCRIPTION
#1	4091231	Drain Gate	#62	4091141	Axle Bracket
#1A	4093041	Spout, for Drain Gate	#63	4090611	1/4-20 X 3/4 Hex Bolt
#2	4090581	Screw, 10-32 X 5/8, S/S	#64	4093211	Axle, 1/2" X 17-1/2"
#3	4091251	Latch	#65	4091311	Louver, 3" (includes 3 screws)
#4	4091161	O-Ring, Thin	#66	4091611	Gasket
#4A	4091171	O-Ring, Thick	#67	4094041	Base, Black, specify Model
#4B	4090701	Nut, Cast Aluminum	#68	4093051	Castor, 4" Swivel
#5	4093191	Vacuum Tank, Black, specify model	#70	4091031	Quick Disconnect, Male, 1/4 p.t.
#6	4091241	Hose Barb, 1-1/2", plastic	#71	4091261	Latch Strike
#7	4091291	PVC Elbow, 1-1/2"	#72	4091401	Handle, Chrome
#8	4091391	Gasket, for Vacuum Dome	#73	4090601	1/4-20 X 3/4, Flathead Phillips
#9	4091581	Vacuum Dome	#74	4093151	Funnel, Black
#10	4091501	Float, Ball & Cage	#75	4093181	Holding Tank, Specify Model
#11	4091571	Vac Shut-off, Manifold Assy.	#76	4091191	Filter, Pump Inlet
#12	4090701	Nut, Cast Aluminum	#77	4093031	Lid, with Label, no hinges
#13	4091171	O-Ring, Thick	#78	4091041	Switch, SPST, Covered, w/light
#14	4091291	PVC Elbow, 1-1/2"	#79	4091051	Switch, DPDT, Covered, w/light (N/A on 240V)
#15	4091121	Hose Clamp, size 28	#80	4090031	Switch Plate, empty, CXH300
#16	4091551	Hose, Rubber, 2" X 20"	#81	4094031	Red Light, 120V
#17	4091061	Hose Clamp, size 36		4095391	Red Light, 240V
#18	4091221	Heat Exchanger Mount	#82	4090511	#4 X 3/8 Screw, Panhead Phillips
#19	4095331	Heat Exchanger, Complete, CXH300, 120V	#83	4091071	Green Light, 120V (N/A on 240V)
	4095421	Heat Exchanger, Complete, CXH300, 240V	#84	4095071	Elbow, Brass, 1/4 p.t., 90 degree
#20	4091091	Elbow, Brass, 1/8 p.t., 90 degree	#85	4095031	Hose Barb, Brass, 1/4 p.t. X 1/2 Hose
#21	4091421	Hose, High Pressure, 1/4 ID X 26"	#86	4091131	Hose Clamp
#22	4095111	Quick Disconnect, Female, 1/8 p.t.	#87	4095241	Hose, Pump Inlet, 1/2" X 14"
#23	4091121	Quick Disconnect, Male, 1/8 p.t.	#88	4095251	Pump, 300 PSI, no plumbing
#24	4095011	Bushing, Brass	#89	4095041	"T", Brass, 1/4 p.t.
#25	4094061	Elbow and Pipe Assembly	#90	4093091	Nipple, 1/4 p.t., S/S
#26	9122470	Washer, Brass, 1"OD X9/16"ID X 1/16"	#91	4093091	Elbow, Brass, 1/4 p.t., 90 degree
#26A	4090691	Washer, Vulcanized Rubber	#92	4095101	Quick Disconnect, Male, 1/4 p.t.
#27	4093091	Nipple, 1/4 p.t., S/S	#93	4095221	Hose, Pulsation Dampening
#28	4091111	Bushing, Vulcanized Fiber	#94	4095151	Hose, 1/8 ID X 24", with swages
#29	4093091	Nipple, 1/4 p.t., S/S	#95	4095061	Plug, Brass, 1/4 p.t.
#30	9121430	5/16 Hex Jam Nut, w/Ny-Lok	#96	4095021	Nipple, Reducing, Brass, 1/4 X 1/8 p.t.
#31	4090611	5/16 Flat Washer, ZP	#97	4093011	Hose Barb, Brass, 1/4 p.t. X 3/8 Hose
#32	4091181	Split Ring	#98	4095231	Bypass Valve
#32A	4095341	Stop Chain, 9.5"	#99	4095191	Hose, Rubber, 3/8 X 8"
#33	9121420	5/16 Hex Nut, w/Ny-Lok	#100	4093011	Hose Barb, Brass, 1/4p.t. X 3/8 Hose
#34	9121520	5/16 Washer	#101	4095301	Solenoid Valve, 120V
#35	4090651	5/16" X 4" Bolt, Full Threads, ZP		4095441	Solenoid Valve, 240V
#36	4095211	PVC Sleeve, 1-1/2" X 3"	#102	4095191	Hose, Pump Bypass, 3/8 X 14"
#37	4095181	PVC Elbow, 1-1/2" Slip	#103	4095291	Motor, AC for Pump, 120V
#38	4095201	Manifold, Vacuum		4095451	Motor, AC for Pump, 240V
#39	4095271	Gasket, Vac Motor	#104	4091521	Cord Wrap
#40	4095171	Vacuum Motor, 3-Stage, 120V	#105	1391161	Washer, Plastic, 5/8OD X 3/8ID X 1/16
	4095411	Vacuum Motor, 3-Stage, 240V	#106	4090671	3/8 Acorn Nut
#41	4090541	6-32 X 2" Screw, Panhead, S/S			
#42	4091451	Fan Guard			
#43	4090531	6-32 Hex Nut, w/Ny-Lok			
#44	4091441	Cooling Fan, 120V			
	4092131	Cooling Fan, 240V			
#45	4095161	Louver, 2-1/2" (includes 3 screws)			
#46	4091331	PVC Reducer			
#47	9120900	1/4 Hex Nut, w/Ny-Lok			
#48	9121270	3/4" X 1" Hex Bolt			
#49	4091281	Heat Sink Plate			
#50	can't order	Thermistor Contol w/potentiometer* (see misc.)			
#51	4091151	Cord Retainer w/Stain Relief			
#52	4095051	Snubber, Pulsation Dampening			
#53	4095091	Quick Disconnect, Female, 1/4p.t.			
#54	4095081	Quick Disconnect, Male, 1/4 p.t.			
#55	4095261	Pressure Gauge			
#56	4091301	Dual Cord Sensor Circuit Board (N/A on 240V)			
#57	4091321	Snap Track (N/A on 240V)			
#58	4091361	Wheel, 8"			
#59	4091021	Axle Cap			
#60	4090071	Label, NSS			
#61	9120900	1/4 Hex Nut, w/Ny-Lok			

MISCELLANEOUS ASSEMBLIES/PARTS

4095141	Bypass Valve Rebuild Kit
4095131	Pump Rebuild Kit, Valves & O-Rings
4095381	Pump Rebuild Kit, Piston & Seals
4095461	Bearing & Cam Assembly
4095351	Pump Complete, no motor or solenoid
4091461*	Thermistor Control Kit w/Potentiometer & Probe (240V, #4091721)
4091471*	Thermistor Control Kit w/Pot., Probe & Cutout (240V, #4091731)
4093161	Drain Gate Assembly, complete with O-ring & Nut

(NOTE: Items in kits not sold separately.)

NOT SHOWN

4090251	Power Cord, 120V
4090261	Power Cord, 240V

PREDATOR CX300HP

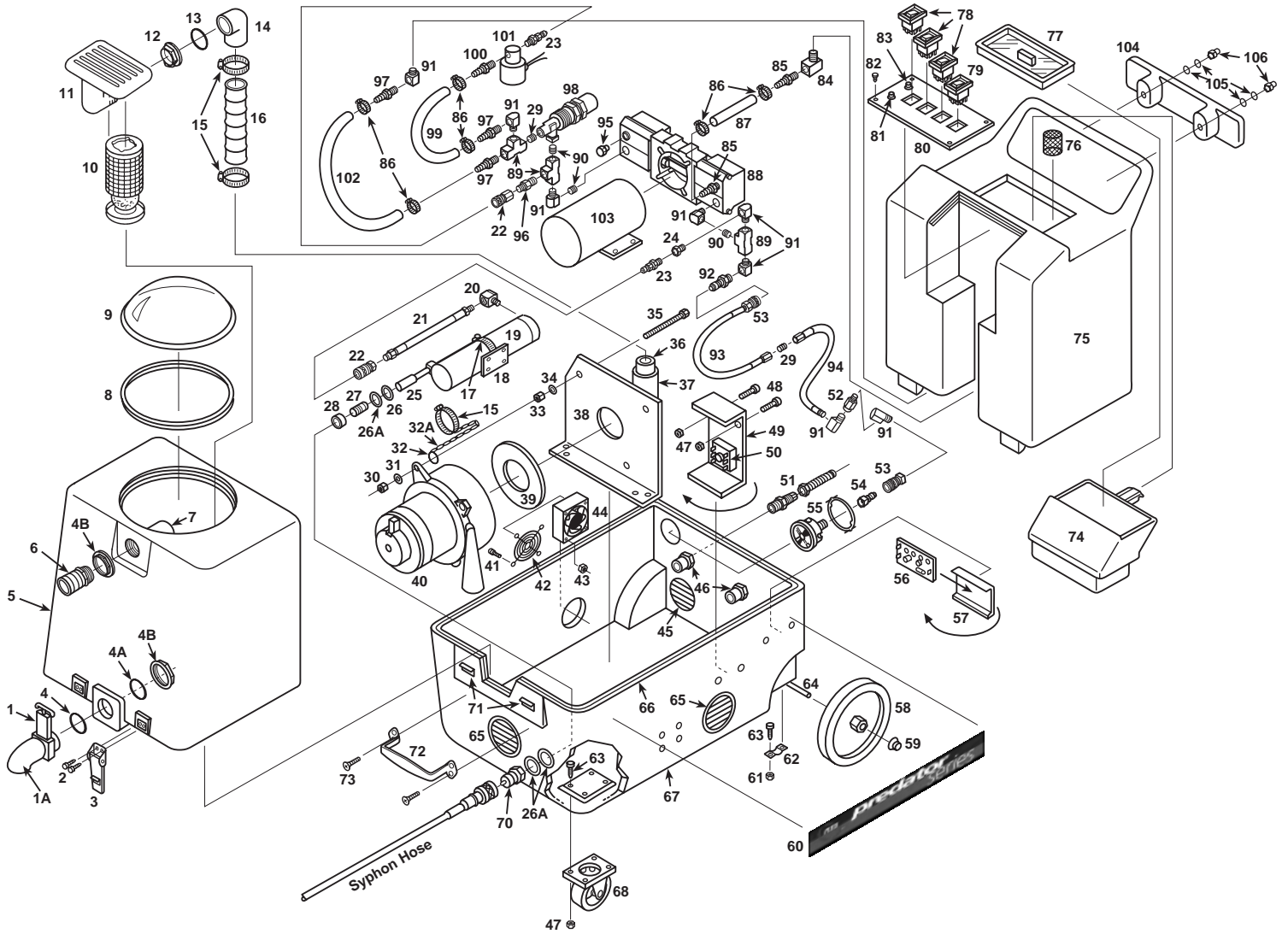

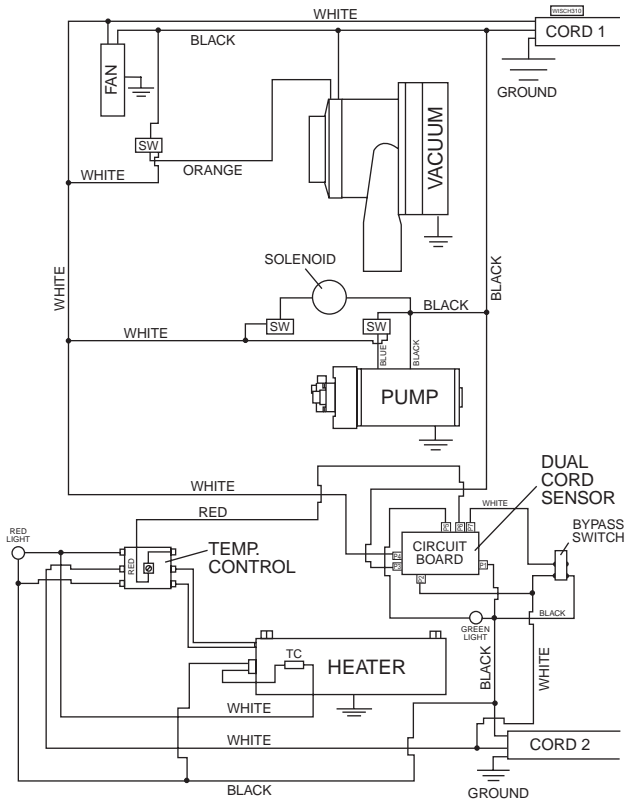

PREDATOR CX300HP WIRING DIAGRAM 120V

6/21/01

PREDATOR CX300HP WIRING DIAGRAM 240V

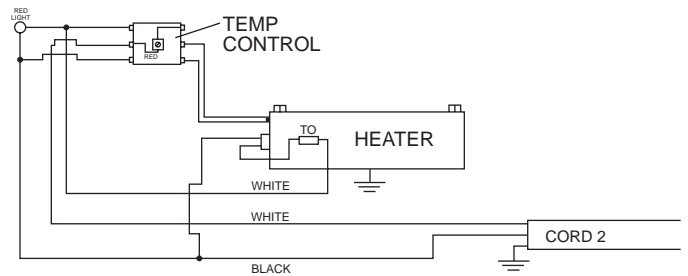
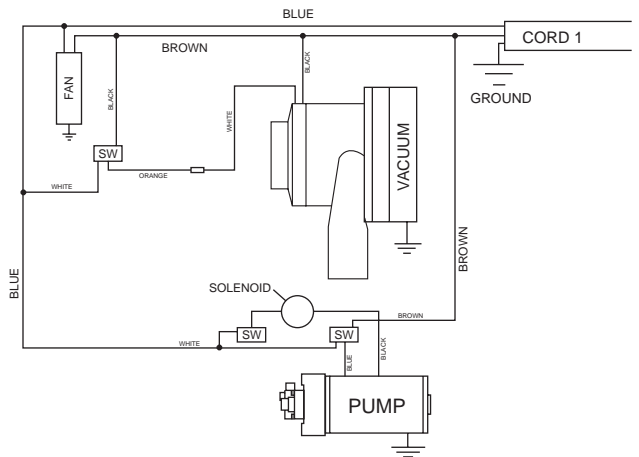

8/10/00

NSS Enterprises, Inc.

3115 Frenchmens Road, Toledo, Ohio 43607
PHONE (419) 531-3761 • FAX (419) 531-3761



NSS® Enterprises, Inc. European Distribution Centre
Unit II, Pinfold Trading Estate 55 Nottingham Road
STAPLEFORD, NOTTINGHAM NG9 8AD ENGLAND U.K.
PHONE: (44) 0115 939 1568 FAX: (44) 0115 949 0615