

PARTS LIST

THOROUGHbred FLOOR MACHINE

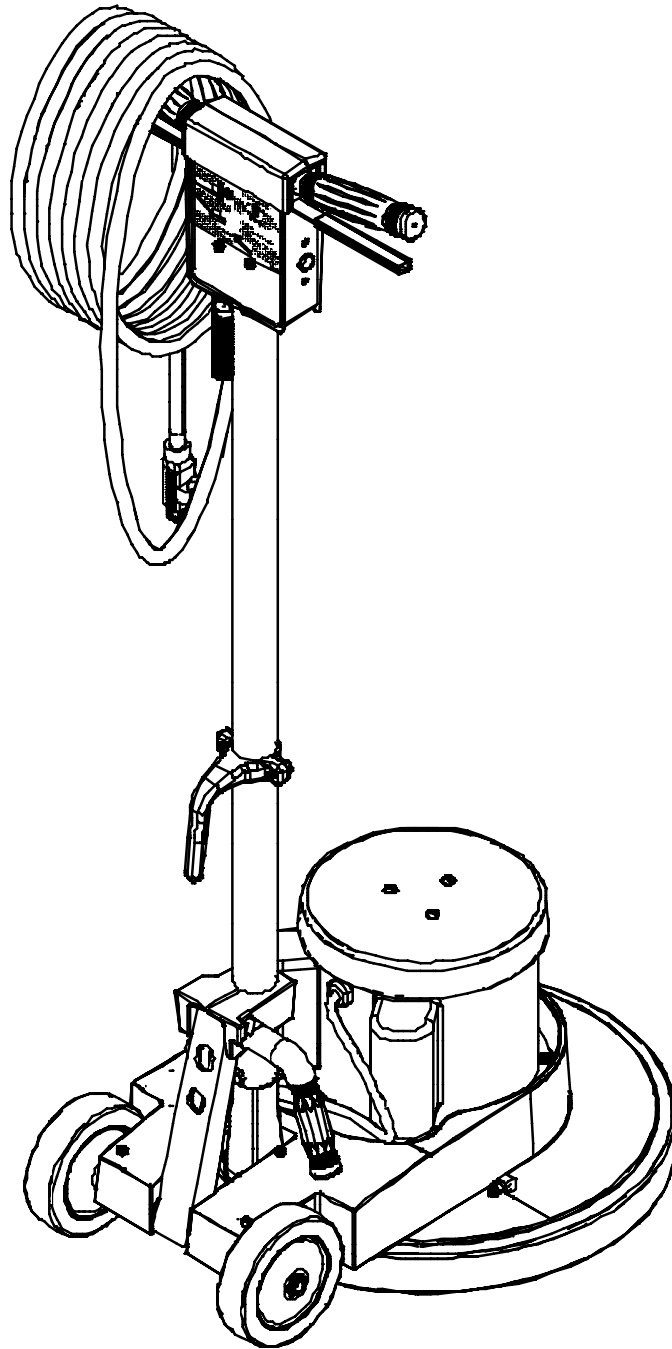

<u>ITEM</u>	<u>PART NO.</u>	<u>PART DESCRIPTION</u>	<u>QTY.</u>
	5095109	THOROUGHbred HANDLE ASSEMBLY - 120 VOLT	1
	5095119	THOROUGHbred HANDLE ASSEMBLY - 240 VOLT	1
101	5092322	BLACK VINYL COVER	1
102	5391873	METAL SWITCH BOX COVER	1
103	5392471	DECAL - "OPERATION"	1
104	9120320	10 SPLIT LOCK WASHER	2
105	9120430	10-24 X 3/4 ROUND HEAD PHILLIPS MACHINE SCREW	2
106	5091611	HANDLE GRIP	2
107	5091661	CORD CLAMP	1
108	5091656	7/8 I.D. X 1 3/8 O.D. X .112 THICK FLAT WASHER	1
109	8791070	VINYL TUBE	1
110	5092331	FLAG TERMINAL - 120 VOLT	1
111	5390171	SPRING	2
112	5390776	SWITCH LEVER	1
113	9120050	6-32 X 5/16 ROUND HEAD PHILLIPS MACHINE SCREW	2
114	9120130	6 EXTERNAL STAR LOCK WASHER	2
115	5390756	SAFETY LOCKOUT BRACKET	1
116	5390762	SAFETY LOCKOUT	1
117	9120025	6-32 DOUBLE HOLE SWITCH SPEED NUT	1
118	5092561	SAFETY LOCKOUT SPRING	1
119	9120380	10-24 X 3/8 ROUND HEAD PHILLIPS MACHINE SCREW	1
120	9120320	10 SPLIT LOCK WASHER	1
121	5092371	CORD CLAMP - 120 VOLT	1
	0299661	CORD CLAMP - 240 VOLT	1
122	5390261	STRAIN RELIEF NUT - 120 VOLT	2
	0891131	STRAIN RELIEF NUT - 240 VOLT	1
123	5091671	STRAIN RELIEF - 120 VOLT	1
	0299531	STRAIN RELIEF - 240 VOLT	1
124	5091682	CORD HOOK	1
125	5091569	CORD WITH TERMINALS - 50 FEET - 120 VOLT	1
	0299671	SHUKO CORD - 75 FEET - 240 VOLT	1
126	5094511	HANDLE TUBE	1
127	0393631	PLUG/CORD COVER - HANDLE	1
128	5490861	HANDLE CORD	1
129	5091636	CORD HOOK CLAMP	1
130	9120880	1/4 SPLIT LOCK WASHER	2
131	9121010	1/4-20 X 3/4 TRUSS HEAD PHILLIPS MACHINE SCREW	2
132	0190911	DECAL - "GROUNDING" - 120 VOLT ONLY	1
133	0190901	DECAL - "WARNING" - 120 VOLT ONLY	1
	0190921	DECAL - "ICON ADAPTOR" - 240 VOLT ONLY	1
134	5392401	DECAL - "FIRE WARNING"	1
135	5092511	PLUG BUTTON	1
136	5390541	SWITCH LEVER GRIP	2
137	9120828	1/8 X 1 3/4 ROLL PIN	2
138	0298981	#10 RING TERMINAL - 120 VOLT	1
139	9120320	10 SPLIT LOCK WASHER	1
140	9120380	10-24 X 3/8 ROUND HEAD PHILLIPS MACHINE SCREW - GROUND	1
141	5391321	WIRE NUT - ORANGE - 120 VOLT	1
142	5390511	CUSHION PAD - FOAM	1
143	5093401	IDENTIFIER DECCAL - THOROUGHbred	1
144	5392411	DECAL - "SWITCH BOX "	1
145	9120100	6-32 X 1 ROUND HEAD PHILLIPS MACHINE SCREW	2
146	9120130	6 EXTERNAL STAR LOCK WASHER	2
147	5390211	SWITCH - ON - OFF	1
148	5390361	SWITCH INSULATOR	1
149	5391911	WIRE ASSEMBLY - DEAD MAN TERMINAL - 240 VOLT ONLY	1
150	5391921	WIRE ASSEMBLY - GROUND WIRE - 240 VOLT ONLY	1
151	9120080	6-32 X 3/4 ROUND HEAD PHILLIPS MACHINE SCREW - 240 VOLT ONLY	1
152	5391931	TERMINAL BLOCK - 240 VOLT ONLY	1

HANDLE ASSEMBLY

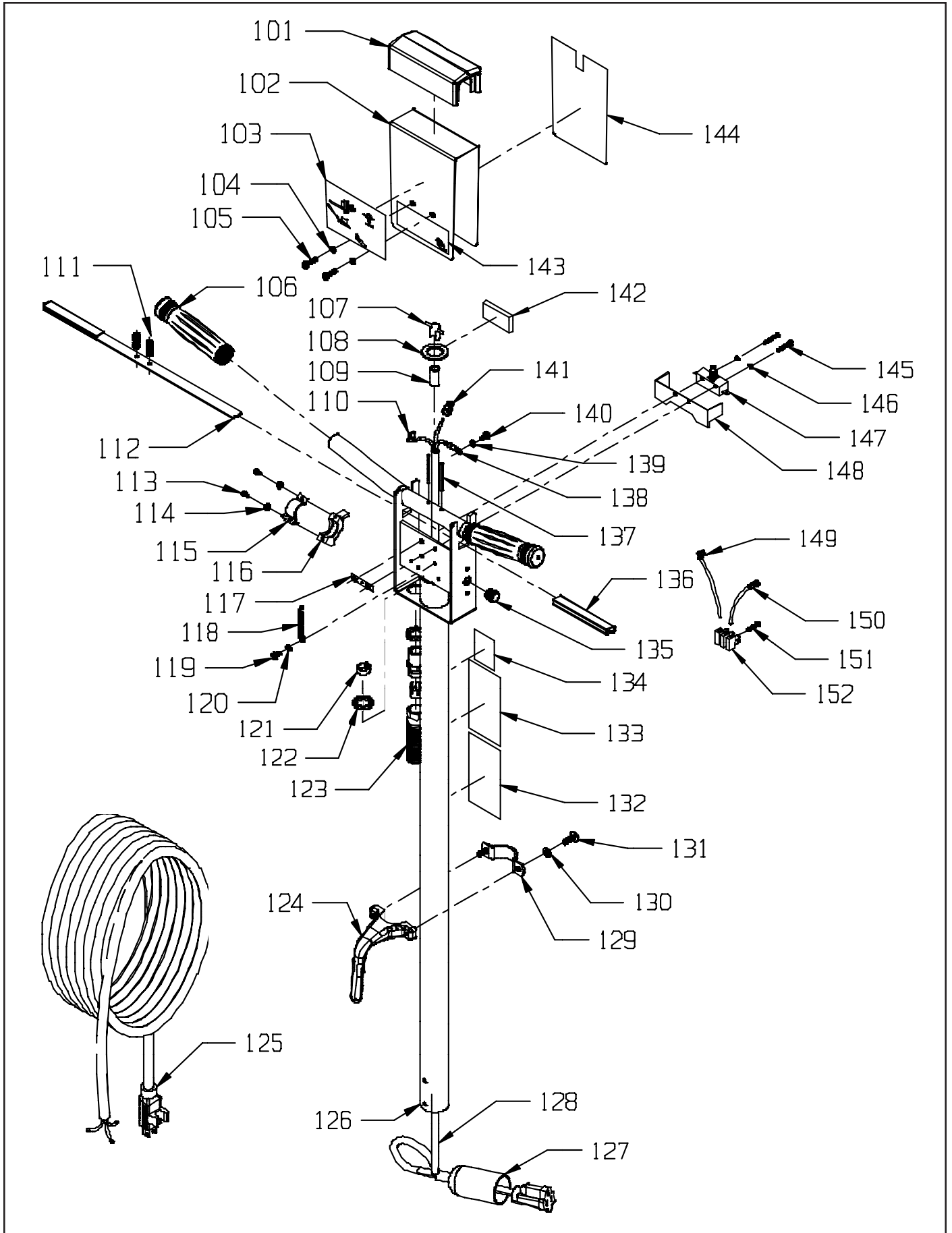

<u>ITEM</u>	<u>PART NO</u>	<u>PART DESCRIPTION</u>	<u>QTY.</u>
201	9120750	10-32 X 1/2 TRUSS HEAD PHILLIPS MACHINE SCREW	3
202	0393111	MOTOR COVER	1
203	5095011	1HP MOTOR 120 VOLT 60HZ 11:1 2P GEAR BOX	1
	5095411	1HP MOTOR 120V60HZ W/CORD,PLUG COVER,END SHIELD - NO GEAR BOX	1
	0394511	STATIONARY SWITCH - IMPERIAL	1
	0394591	CAPACITOR - RUN - 50uF 370V	1
	0394641	CAPACITOR - START - 450uF 165V US	1
203	5095031	1.5HP MOTOR 120 VOLT 60HZ 11:1 3P GEAR BOX	1
	5095431	1.5HP MOTOR 120V60HZ W/CORD,PLUG COVER,END SHIELD - NO GEAR BOX	1
	0394511	STATIONARY SWITCH - IMPERIAL	1
	0394631	CAPACITOR - RUN - 60uF 250V	1
	0394641	CAPACITOR - START - 450uF 165V US	1
203	5095041	1.5HP MOTOR 240 VOLT 50HZ 11:1 3P GEAR BOX	1
	5095441	1.5HP MOTOR 240V50HZ W/CORD,PLUG COVER,END SHIELD - NO GEAR BOX	1
	0394511	STATIONARY SWITCH - IMPERIAL	1
	0394631	CAPACITOR - RUN - 60uF 250V	1
	0394641	CAPACITOR - START - 450uF 165V US	1
203	5095051	2HP MOTOR 240 VOLT 50HZ 11:1 3P GEAR BOX	1
	5095451	2HP MOTOR 240V 50HZ W/CORD,PLUG COVER, END SHIELD - NO GEAR BOX	1
	0394511	STATIONARY SWITCH - IMPERIAL	1
	0394631	CAPACITOR - RUN - 60uF 250V	1
	0394641	CAPACITOR - START - 450uF 165V US	1
203A	0393621	PLUG / CORD COVER - MOTOR	1
203B	0394621	GEAR BOX 10:1 3P W/END SHIELD & FLEX COUPLING	1
203B1	5095301	COUPLING, FLEXIBLE	1
203B	5095251	GEAR BOX 10:1 3P W/OUT END SHIELD & FLEX COUPLING	1
204`	9120570	10-24 X 1 3/4 SOCKET HEAD CAP SCREW	2
205	9120900	1/4-20 HEX NUT WITH NY-LOK INSERT	2
206	5094511	HANDLE TUBE	1
207	9121145	1/4-20 X 2 HEX BOLT	2
208	5090436	CLAMP BOLT	1
209	9121980	7/16 I.D. X 1 O.D. X .075/.080 THICK FLAT WASHER (3/8)	1
210	5090175	TUBE CLAMP	1
211	9120850	1/4-20 X 5/16 SET SCREW - KNURL POINT	1
212	5090182	TUBE CASTING	1
213	5090219	HANDLE LINK ASSEMBLY	1
214	5090166	AXLE	1
215	5090481	5/8 RETAINING RING	2
216	5091711	WHEEL SPRING	2
217	5092591	WHEEL 5" WITH PLASTIC BEARING	2
218	5090491	DECAL - "WHEEL COVER"	2
219	9122465	.516 I.D. X .813 O.D. X .027/.030 THICK FLAT WASHER (1/2)	2
220	9122496	RETAINING RING	2
221	9121545	5/16-18 X 2 1/2 SOCKET HEAD CAP SCREW	4
222	9121520	5/16 SPLIT LOCK WASHER	4
223	9121390	11/32 I.D. X 11/16 O.D. X .051/.080 THICK FLAT WASHER (5/16)	4
224	5092641	RETAINING RING - SOLUTION FEED TUBE	1
225	5090371	BUMPER - 17"	1
	5090401	BUMPER - 20"	1
226	9120850	1/4-20 X 5/16 SET SCREW - KNURL POINT	1
227	9998061	3/16" NYLON ROD	.016
228	9120350	10-24 HEX NUT WITH NY-LOK INSERT	2
229	5090246	HANDLE PIVOT STUD	1
230	5090441	NYLON BUSHING	2
231	5091621	HANDLE GRIP	1
232	5091725	LOCKING LEVER	1
233	5092531	SOLUTION FEED TUBE CAP	1
234	5090045	SKIRT - 17"	1
	5090065	SKIRT - 20"	1
235	5092632	SOLUTION FEED TUBE - 90°	1
236	5095001	MOTOR MOUNT BASE - T-BRED	1
237	5091691	RUBBER MOUNT PAD	4
238	5296451	CLOUD BURST DECAL - 3 X 12	1

BASE ASSEMBLY

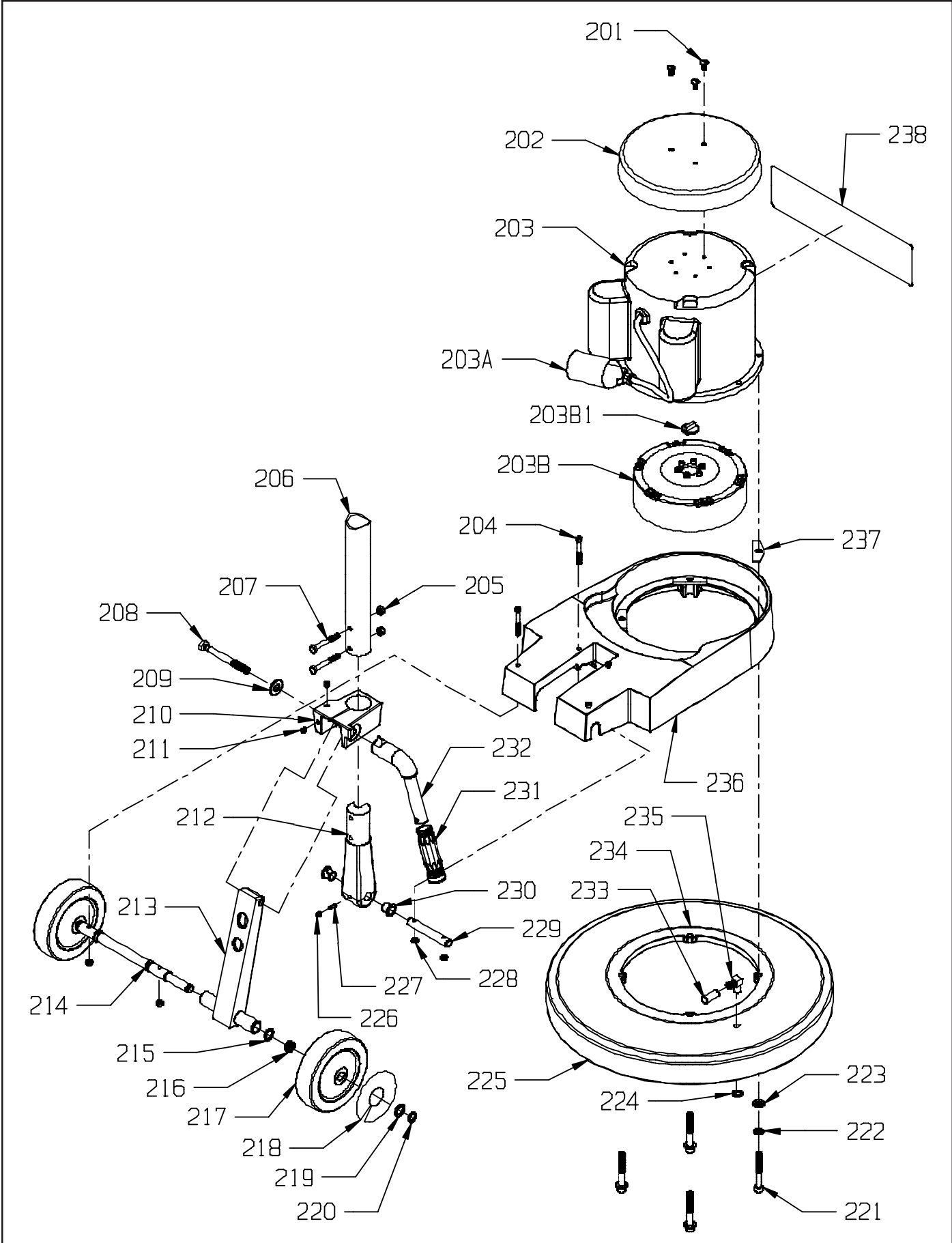

WIRE DIAGRAM

120 VOLT

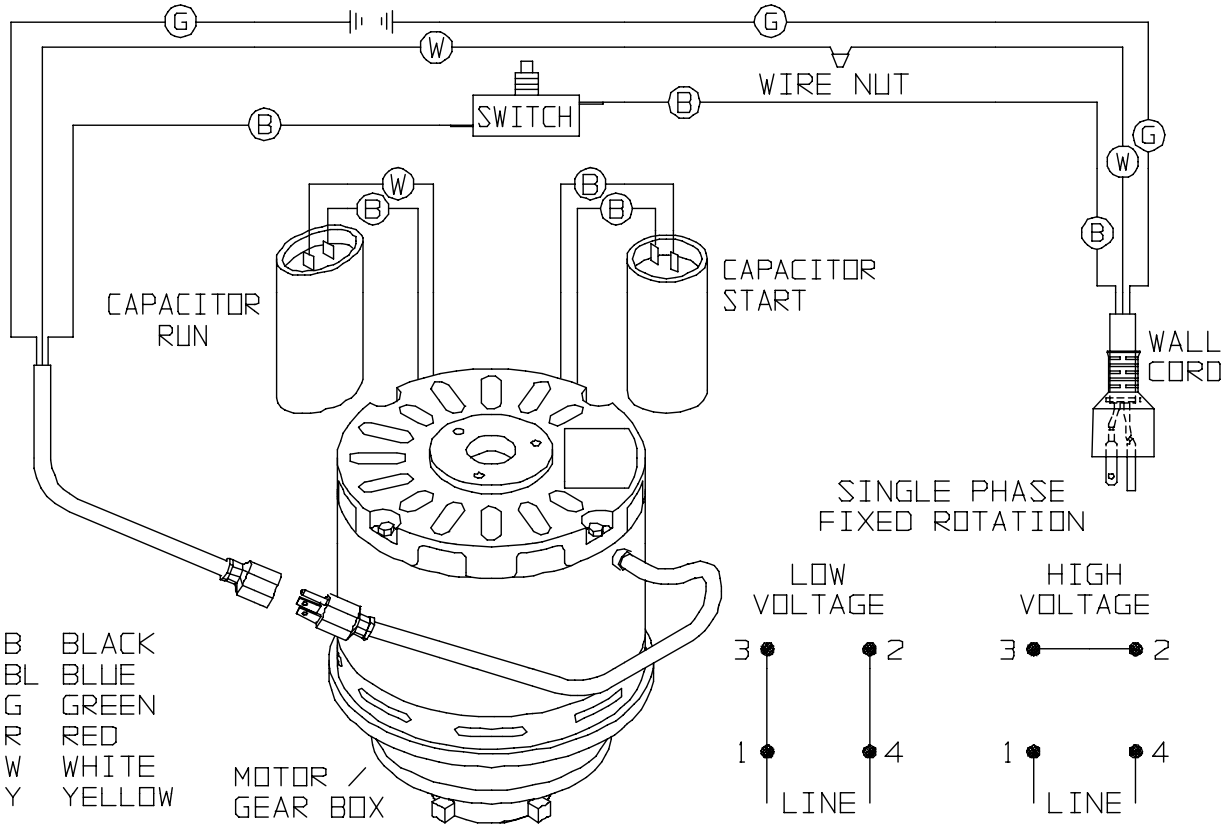

240 VOLT

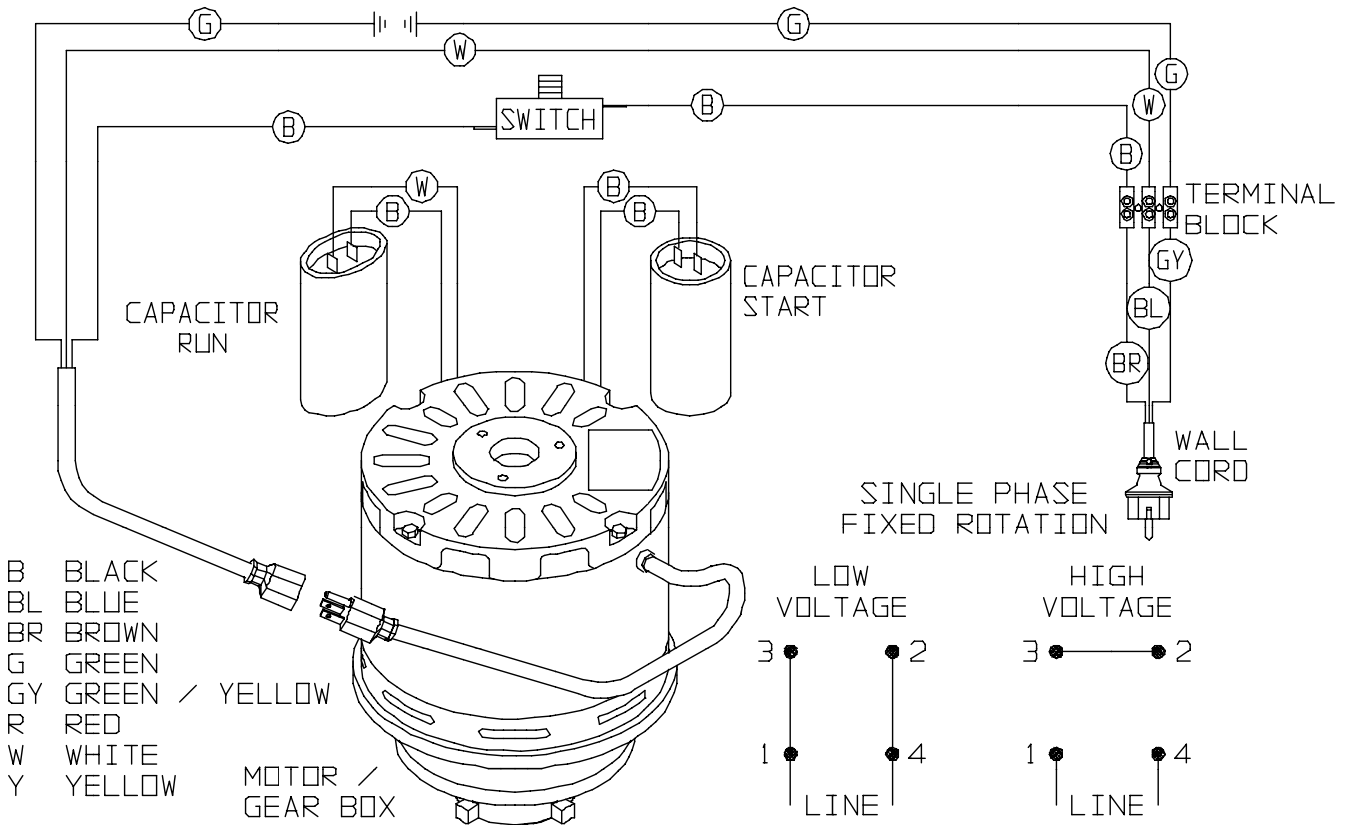

WEIGHT OPTION / SOLUTION TANK ACCESSORY

ITEM	PART #	PART DESCRIPTION	QTY.
301	9121440	5-16-18 WING NUT	3
302	5491303	ADD ON WEIGHT - 10 POUNDS	2
303	5491293	MOUNTED WEIGHT	1
304	5491311	WEIGHT MOUNTING STUD	3
305	9121450	5/16-18 HEX NUT WITH NY-LOK INSERT	3
306	5491345	SKIRT 17" WITH HOLES FOR WEIGHTS	1

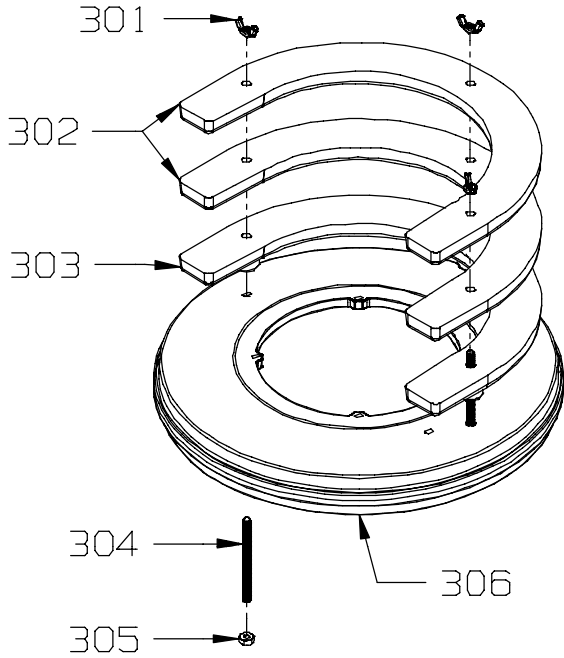

**WEIGHT CAN ONLY
BE ADDED TO A 17"
1.5 OR 2 HP MACHINE**

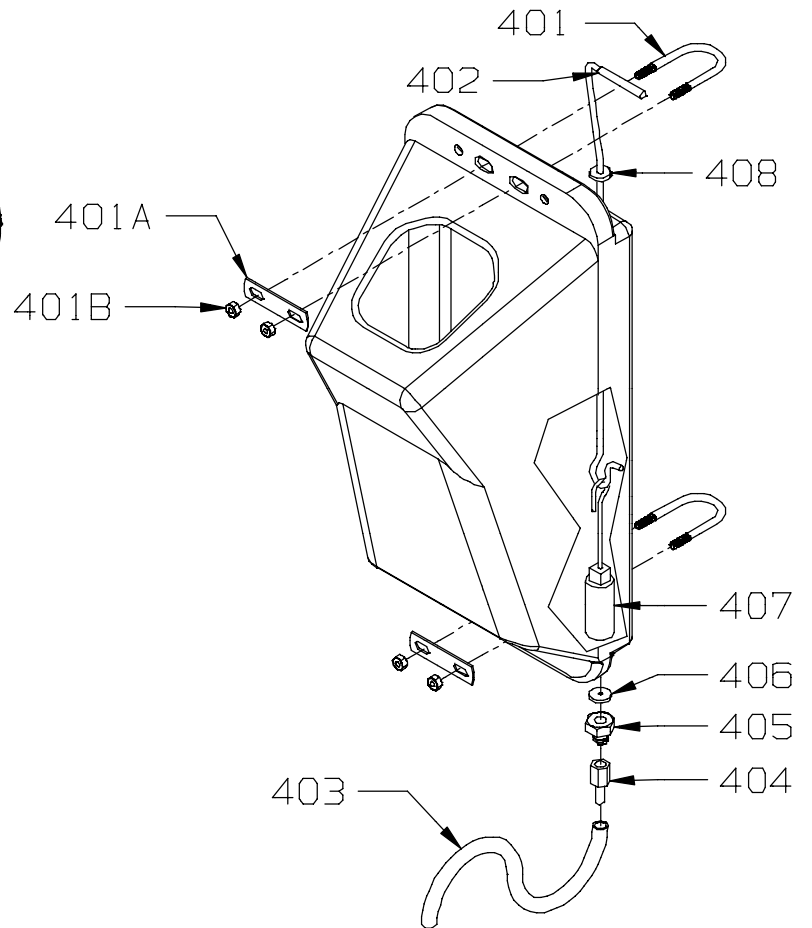

ITEM	PART #	PART DESCRIPTION	QTY.
	5094751	4 GALLON SOLUTION TANK COMPLETE	1
	5094761	2 GALLON SOLUTION TANK COMPLETE	1
401	5094281	5-16-18 U-BOLT ASSEMBLY - INCLUDES:	2
401A	5094281	WASHER BAR	2
401B	9121420	5/16-18 HEX NUT	4
402	5094221	HANDLE ROD - INCLUDES:	1
	5094211	VINYL HANDLE GRIP	1
403	8791020	SOLUTION TUBE	1.67
404	5094191	1/4 NPT X 5/16 HOSE BARB	1
405	5094271	1/4 PIPE NUT	1
406	5094261	NEOPRENE WASHER	1
407	5094241	SOLUTION VALVE ASSEMBLY	1
408	5094231	GROMMET	1

ACCESSORIES



- 2890101 PLASTIC CLUTCH PLATE - 5" DIAMETER - 6 HOLES
- 2890981 PLASTIC CLUTCH PLATE - 4" DIAMETER - 3 HOLES
- 2890991 ALUMINUM CLUTCH PLATE - 5" DIAMETER - 6 HOLES
- 2893001 ALUMINUM CLUTCH PLATE - 4" DIAMETER - 3 HOLES



- 2897211 17" POLY BACK TUFTED PAD DRIVER
- 2897601 17" STRUCTURAL FOAM PAD DRIVER
- 2897201 17" POLY BACK NYLON FILL SCRUB BRUSH - LIGHT TO MEDIUM SCRUB
- 2897711 17" POLY BACK NYLON GRIT FILL SCRUB BRUSH - HEAVY CONCRETE SCRUB
- 2897821 17" POLY BACK NYLON - SOFT SCRUB BRUSH - CARPET ONLY
- 2897901 17" POLY BACK SCRUB GRIT BRUSH - MILD TO MEDIUM SCRUB



- 2892211 20" POLY BACK TUFTED PAD DRIVER
- 2892601 20" STRUCTURAL FOAM PAD DRIVER
- 2892201 20" POLY BACK NYLON FILL SCRUB BRUSH - LIGHT TO MEDIUM SCRUB
- 2892651 20" POLY BACK NYLON FILL SCRUB BRUSH - WITH GUIDE FOR CARPET SHAMPOOING
- 2892711 20" POLY BACK NYLON GRIT FILL SCRUB BRUSH - HEAVY CONCRETE SCRUB
- 2892031 20" PLASTIC BACK BASSINE SCRUB BRUSH - GENERAL SCRUB
- 2892701 20" POLY BRUSH - SHOWER FEED - STANDARD CARPET SCRUB
- 2892901 20" POLY BACK SCRUB GRIT BRUSH - MILD TO MEDIUM SCRUB

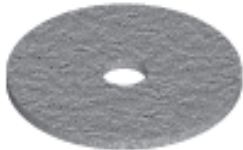

- NOTE: ALL PADS COME 5 (FIVE) PADS PER CASE
- 7991751 17" LITE BLUE POLISH/BURNISH PAD - SOFT FINISH
 - 7991741 17" UHS CLEAN BUFF PAD - REMOVE SCUFF MARKS NOT FINISH
 - 7991731 17" BLUE SCRUB PAD - TOP SCRUB AND LIGHT FINISH REMOVAL
 - 7991721 17" GREEN SCRUB PAD - HEAVY FINISH REMOVAL
 - 7991701 17" BLACK STRIP PAD - REMOVES FINISH COMPLETELY
 - 7992051 20" LITE BLUE POLISH/BURNISH PAD - SOFT FINISH
 - 7992041 20" UHS CLEAN BUFF PAD - REMOVE SCUFF MARKS NOT FINISH
 - 7992031 20" BLUE SCRUB PAD - TOP SCRUB AND LIGHT FINISH REMOVAL
 - 7992021 20" GREEN SCRUB PAD - HEAVY FINISH REMOVAL
 - 7992001 20" BLACK STRIP PAD - REMOVES FINISH COMPLETELY
 - 7992011 20" BROWN STRIP PAD - REMOVES FINISH COMPLETELY



- 2890201 SPRAY BUFF APPLICATOR - PUMP UP TYPE



NSS ® Enterprises, Inc.

3115 Frenchmens Road, Toledo, Ohio 43607
 PHONE (419) 531-3761 FAX (419) 531-3761
NSS ® Enterprises, Inc. European Distribution Centre
 Unit II, Pinfold Trading Estate * 55 Nottingham Road
 STAPLEFORD, NOTTINGHAM NG9 8AD ENGLAND U.K.
 PHONE: (44) 0115 939 1568 * FAX: (44) 0115 949 0615